

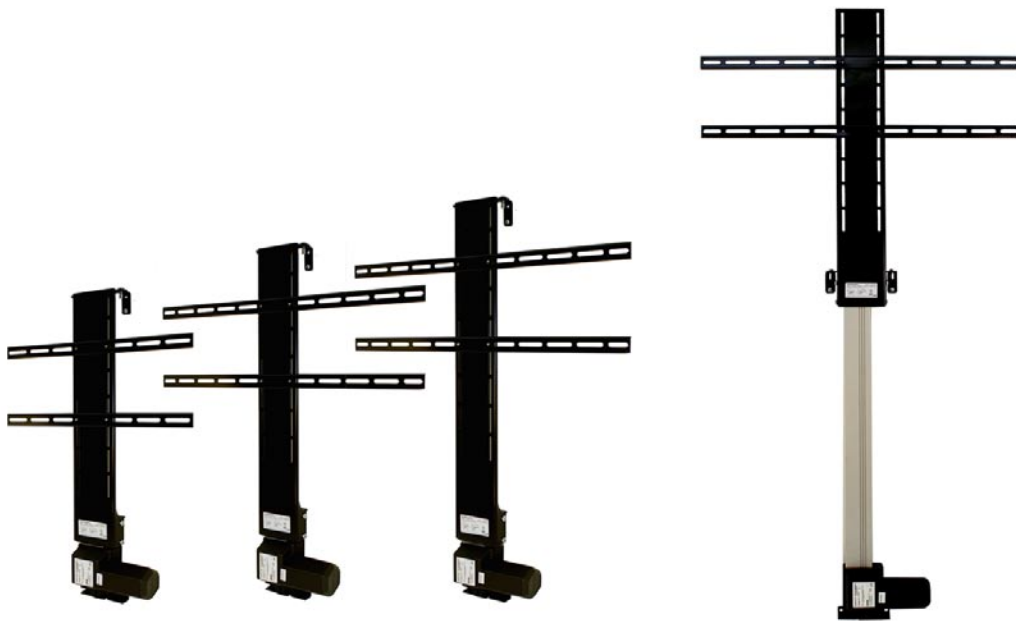

# *User Manual*

## Remote Controlled Motorized Elevator



LVE-6455/6620/6850

## Introduction

The Motorized Elevators are designed to fit most brands on the market. It can be installed to lift up, to lower down from the ceiling or to pop out from the side. The brackets are individual adjustable for flexible applications. The construction is very rigid and easy to install. Maximum load at vertical installation is 50Kg, at horizontal installation 13Kg. In normal application the upper part need wall or top support while the clever quick fix bracket in the lower part can be fastened to either floor or wall which enable flexible installations. The elevators come in two versions; 240V and 12V DC, which is suitable when installing in marine or mobile applications.

If you already have a late edition of Khor or Chameleon LCD from Lava Electronics, you can use the standard TV remote controls special buttons to operate the elevator. If you do not, there are two alternatives: you can program the receiver of the wall mount to operate on your existing remotes or you can use the remote included in the package. This remote also has the key functions, such as volume, program change, source, for operating the Khor and Chameleon LCD-TV.

### General Safety Precautions

- Read the owners manual carefully before installation.
- Installation of the elevator should be made by qualified installer.
- This device is intended for installation of flatscreens in dry areas only.
- Other application is not recommended as it may damage the equipment.
- Do not try to operate the elevator by hand.

# NOTE!

# Assembly

## SE Installation/ ENG Installation

**SE** Läs Manualen före installation! TV-lyften måste monteras säkert på vägg. Sök professionell råd för installationen! Monteringskrav ingår inte. Belastning upp till 50 kg/skrub med 50 kg TV!

**ENG** First read the Owner's manual! The TV elevator must be securely fixed to the wall. Please seek professional advice prior to installation! Mounting screws are not supplied in package. Up to 50 kg load/screw with 50 kg TV!

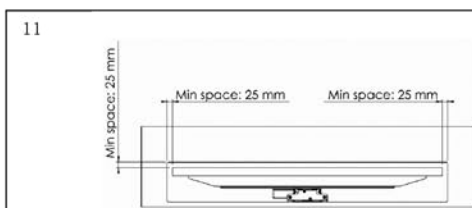
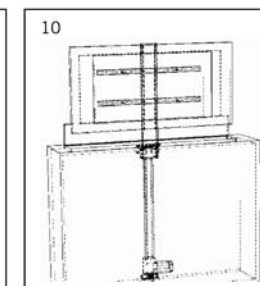
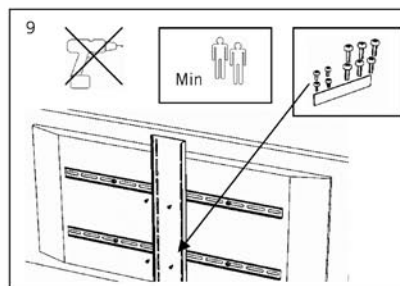
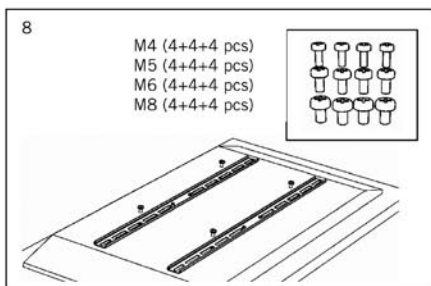
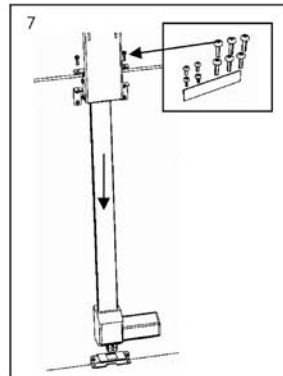
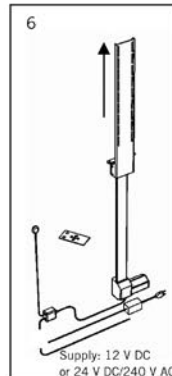
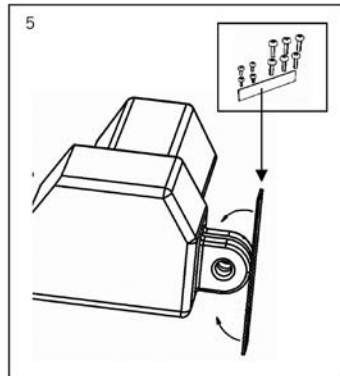
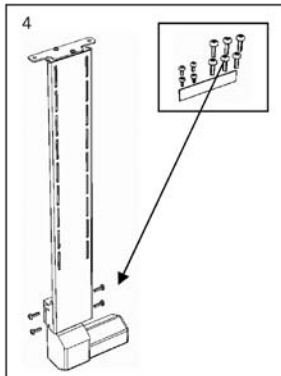
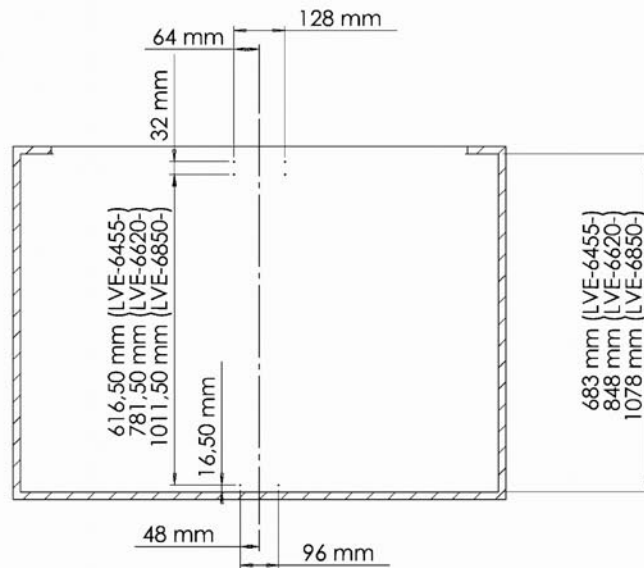
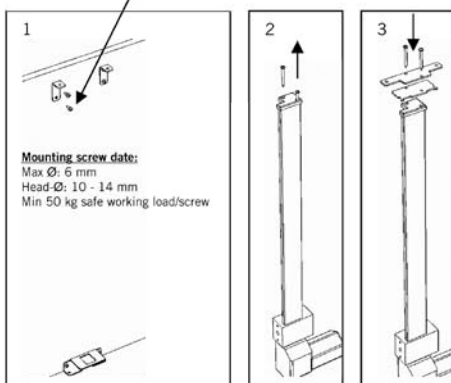

**SE** Klämrisk!  
**ENG** Pinch risk!

# Operation

## Learning

The learnable receiver is pre-programmed to operate with the late edition of Lava Chameleon and Khor series remote controls. If you do not have such TV, please use the enclosed remote (which also can be used to operate the most common functions on the above mentioned Lava models). You can also learn the receiver to operate from one of your existing remotes, for example your TV control. Here is how you do:

**Note!** It is necessary that you wait for at least 1 sec. between pressing the keys when programming.

1. Flip the switch to "Learn Motor 1" mode.
2. Press and hold for 2 sec the button on your remote that you want to use for **up** operation.
3. Release the button, and led flashes red.
4. Press and hold the same button again for 2 sec.
5. Release the button, and the led is green.
6. Press and hold for 2 sec the button on your remote that you want to use for **down** operation.
7. Release the button, and led flashes green.
8. Press and hold the same button again for 2 sec.
9. Release, and the led turns off.
10. Learning completed, flip the switch back to "Operate Mode" and you can start to use.

**!** Even though this device is designed to handle most of the remote formats on the market, some may not work. In this case try another one, or use the enclosed remote.

*The central unit has beside learning and operate mode also a "Lock" function which if it is switched on, disables all functions. This can be used in public places or to prevent children from using the device*



## Using

The in and out function have a 1sec delay in order to avoid any accidental use. Press and hold the button on your remote, and the wall mount starts to move after 1sec. Release the button, and the mount stops and locks in that position.

# Specifications

LVE-6455-240VAC 455mm vertical stroke. 100-380mm horizontal / 40-400mm vertical fitting (15-26 inch)

LVE-6620-240VAC 620mm vertical stroke. 100-630mm horizontal / 40-570mm vertical fitting (27-40 inch)

LVE-6850-240VAC 850mm vertical stroke. 100-630mm horizontal / 40-800mm vertical fitting (41-60 inch)

LVE-6455-12VDC 455mm vertical stroke. 100-380mm horizontal / 40-400mm vertical fitting (15-26 inch)

LVE-6620-12VDC 620mm vertical stroke. 100-630mm horizontal / 40-570mm vertical fitting (27-40 inch)

LVE-6850-12VDC 850mm vertical stroke. 100-630mm horizontal / 40-800mm vertical fitting (41-60 inch)

\* Prefix after modelnumber ex. 240V or 12V indicates operating voltage.

\* 240V models operates on 100-240VAC (AC-Adaptor; secondary 29VDC, 2 A)

\* For illustration of fitting details, look at the rear of this User Manual.





